





---

---

## Escalier exterieur **HOLLYWOOD**

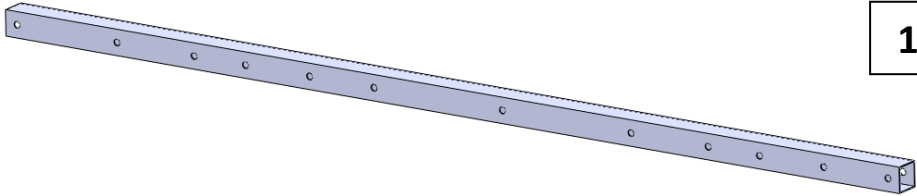
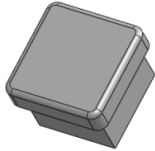
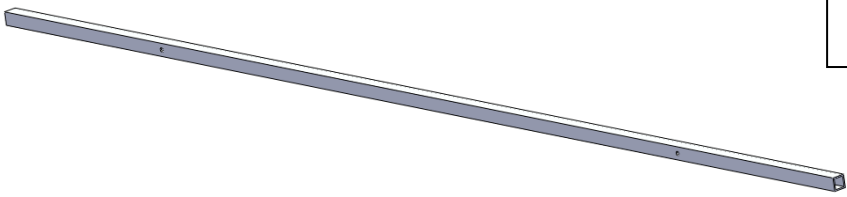
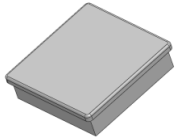
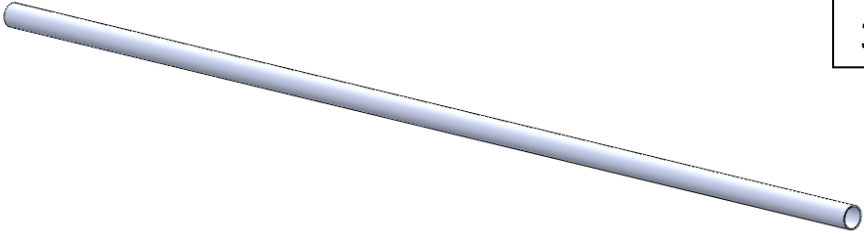
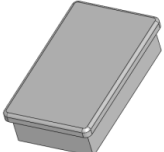
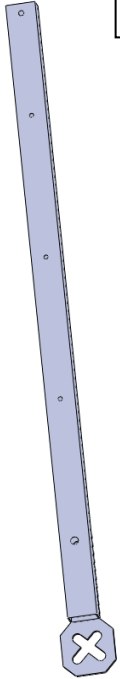
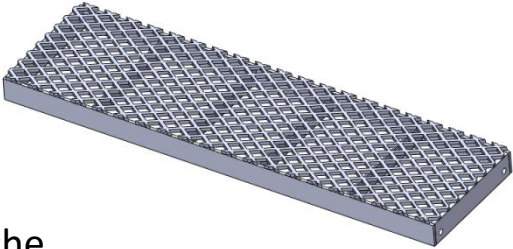
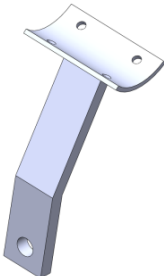

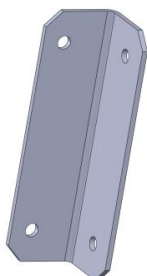

**Liste de pièces**

 <p><b>1</b></p> <p>Limon - 4 pcs</p>	 <p><b>9</b></p> <p>20 x 20 6 pcs / rampe</p>
 <p><b>2</b></p> <p>Rampe - 3 pcs / rampe</p>	 <p><b>10</b></p> <p>50 x 50 4 pcs / limon</p>
 <p><b>3</b></p> <p>Main courante</p>	 <p><b>11</b></p> <p>30 x 50 2 pcs / rampe</p>
 <p><b>4</b></p> <p>Barreaux rampe 2 pcs / rampe</p>	 <p><b>5</b></p> <p>Marche</p>
 <p><b>6</b></p> <p>Support main courante 2 pcs / rampe</p>	 <p><b>7</b></p> <p>Equerres de fixation - mur / palier 2 pcs</p>
 <p><b>8</b></p> <p>Equerres de fixation - sol 2 pcs</p>	 <p><b>12</b></p> <p>Ø40 2 pcs / rampe</p>

Vis

		
13	M8 x 20	1 pce / barreaux rampe
14	M6 x 60	3 pce / barreaux rampe
15	M12 x 70	4 pce / marche
		4 pce / kit de limons
		1 pce / barreaux rampe
16	M12 x 100	1 pce / barreaux rampe

		
20	3,9 x 16	4 pce / barreaux rampe

		
17	M6	3 pce / barreaux rampe
18	M12	4 pce / kit de limons
		2 pce / barreaux rampe
19	M8	1 pce / barreaux rampe

		
21	M6	3 pce / barreaux rampe
22	M12	4 pce / kit de limons
		2 pce / barreaux rampe
23	M12 x ø40	1 pce / barreaux rampe
24	M8	1 pce / barreaux rampe

ATTENTION:

Le matériel de fixation de l'escalier au bâtiment N'est PAS fourni!  
 Vérifiez régulièrement si tous les raccords vissés sont bien serrés!  
 Vérifiez si tout le matériel fourni correspond à la liste de pièces.

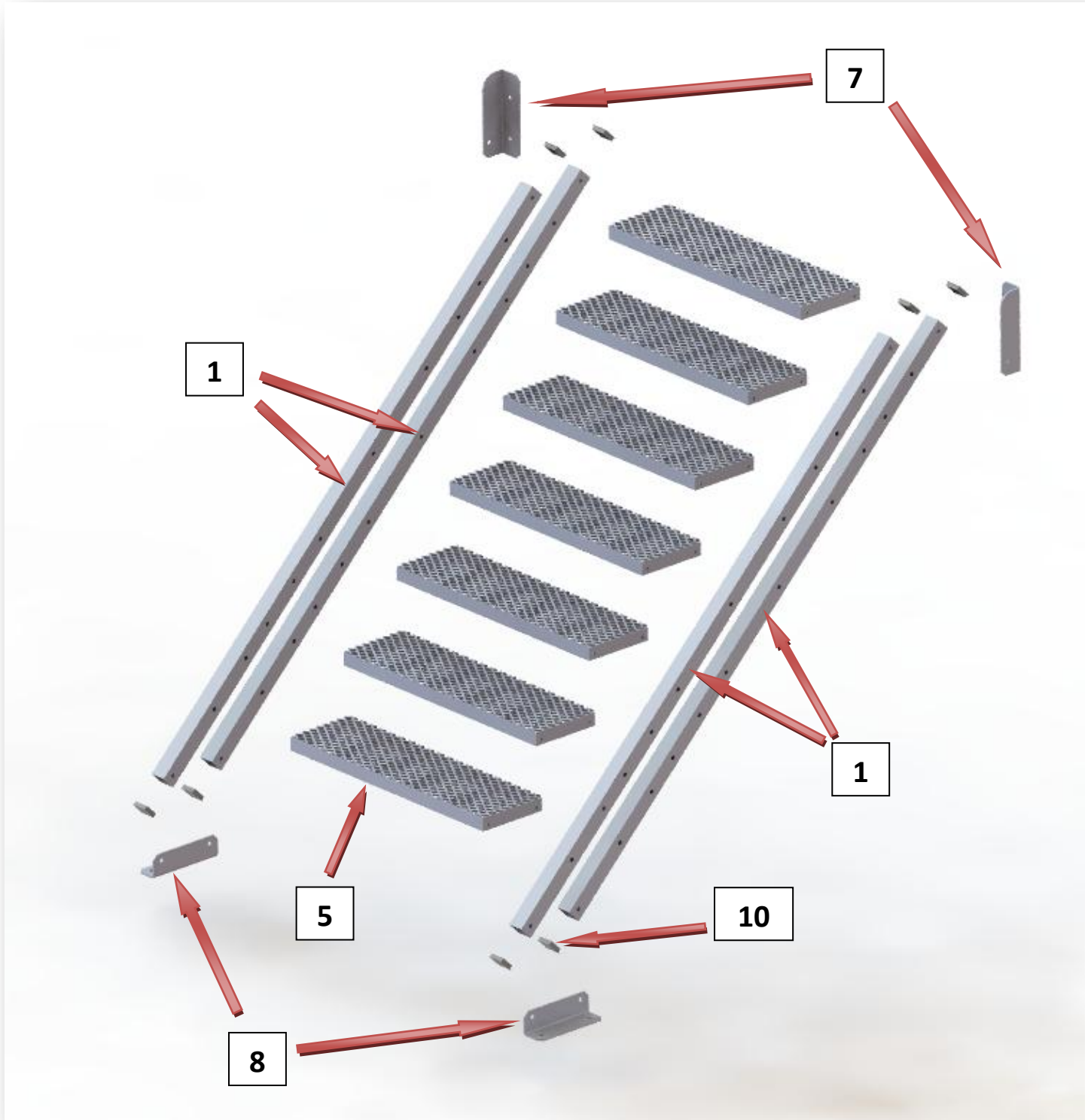

Les marches doivent être montés de telle sorte que la surface large tourné vers l'avant.

La distance entre les trous inférieurs est toujours de 141,5 mm.

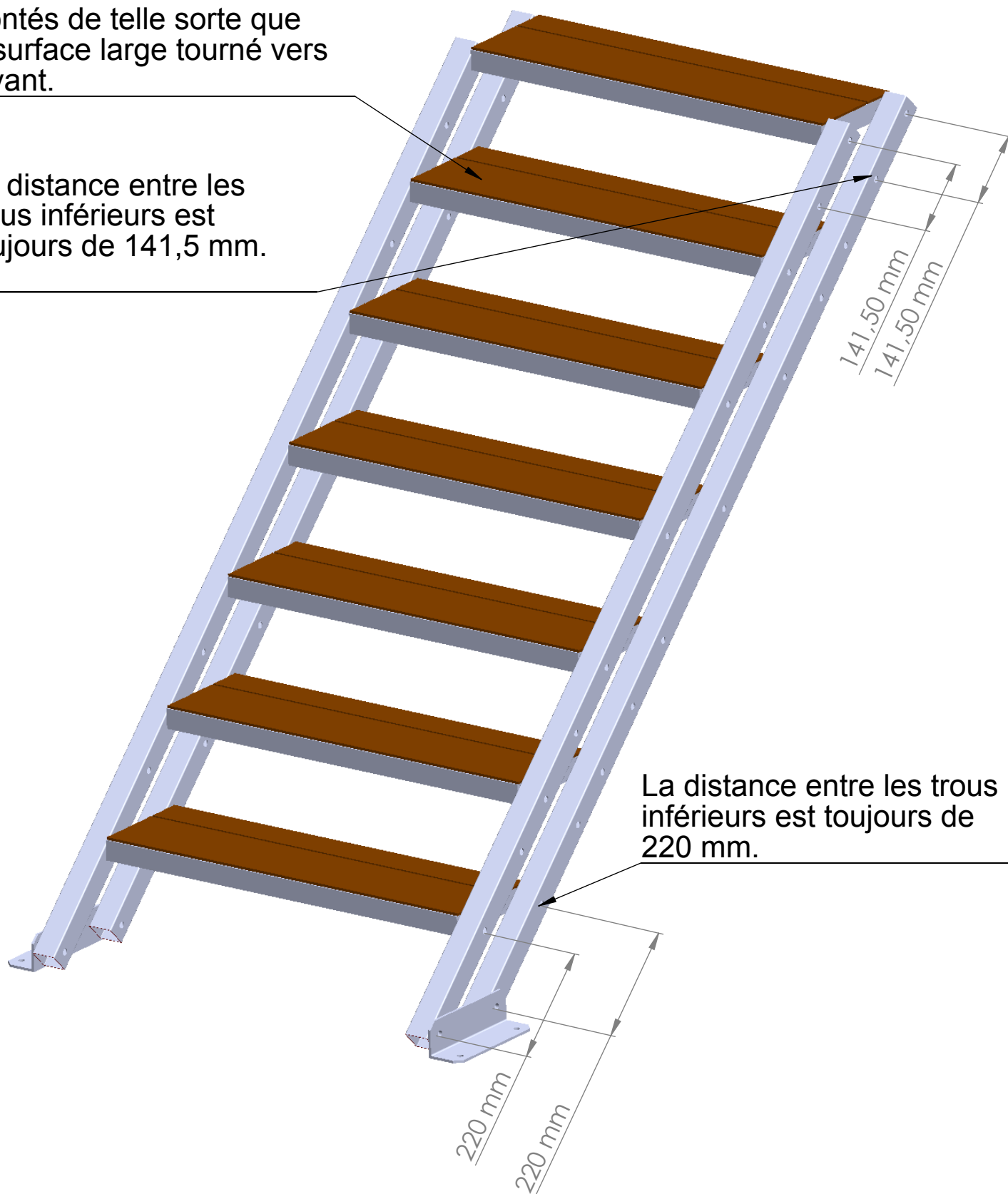

La distance entre les trous inférieurs est toujours de 220 mm.

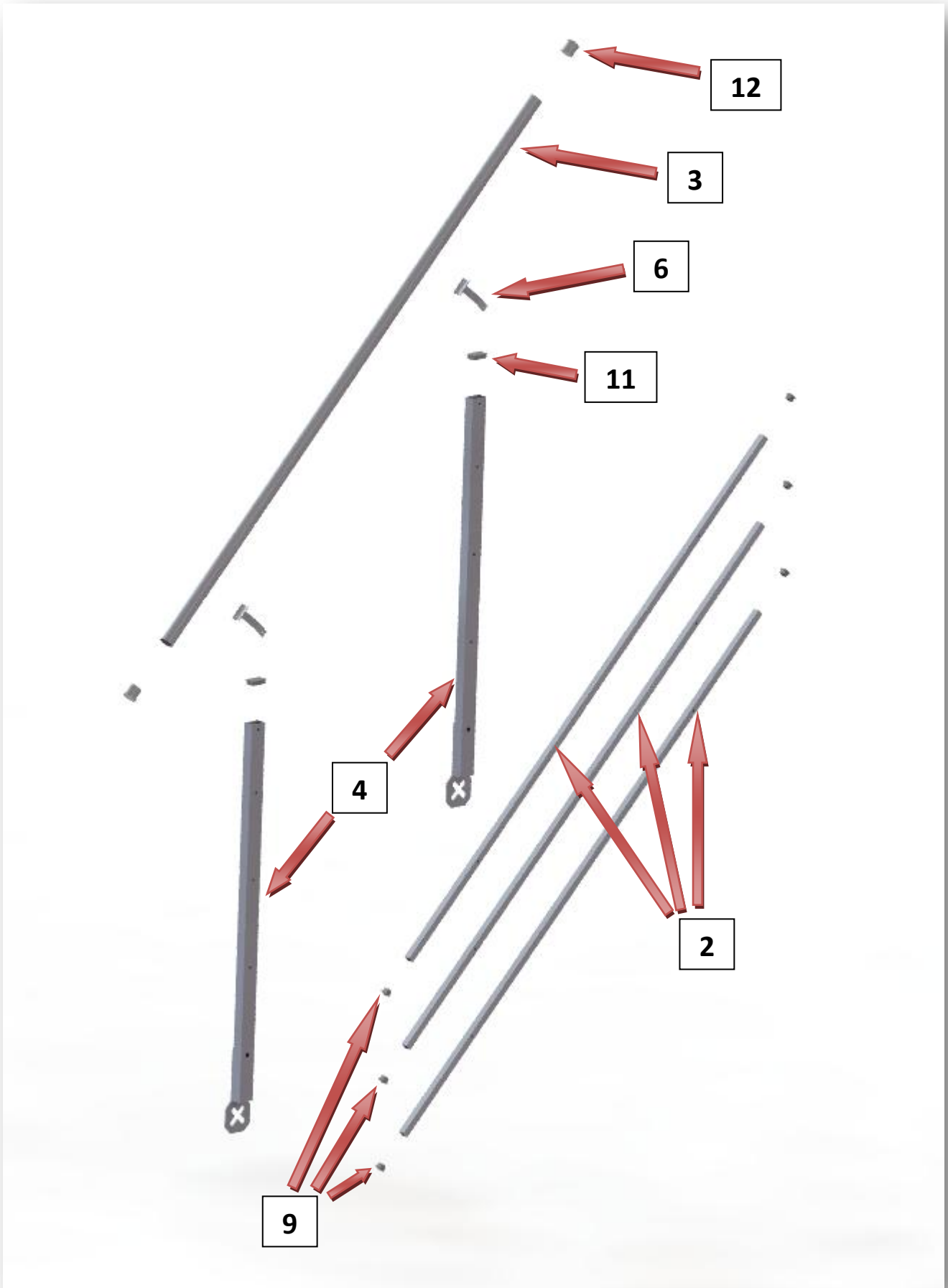

**Etapes de montage**



