

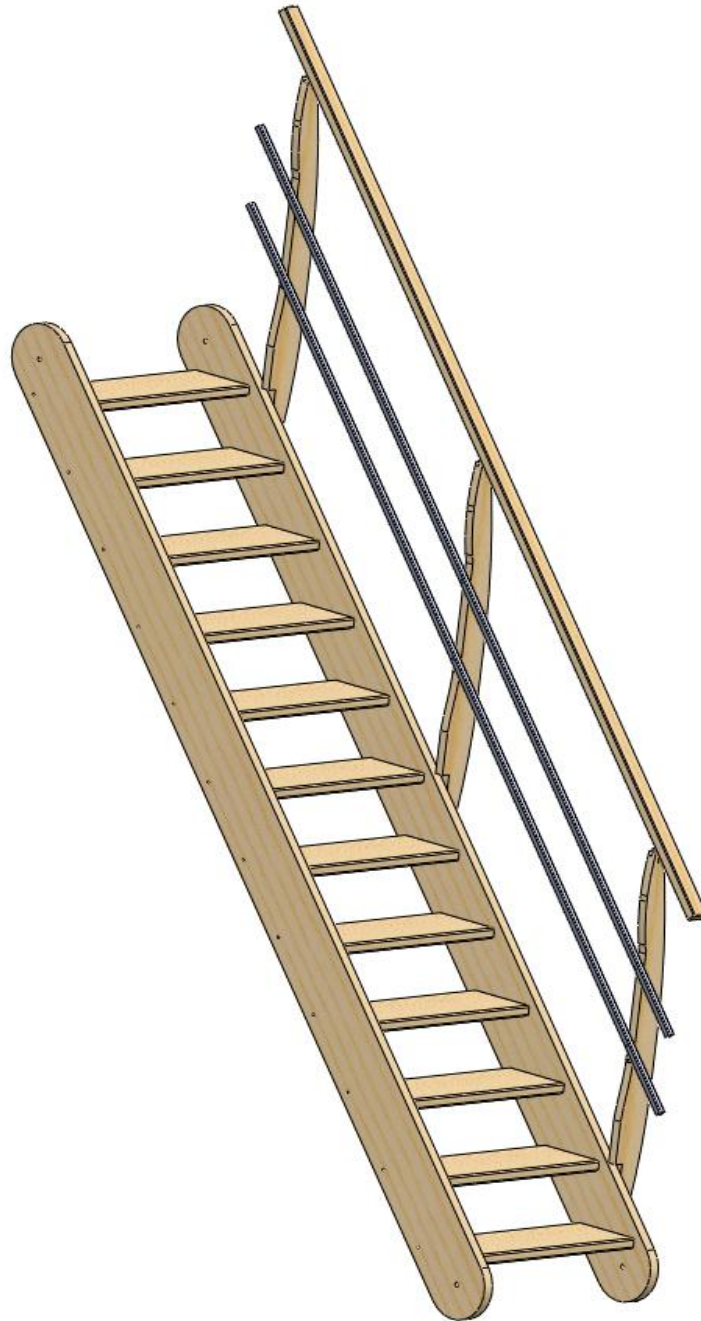















## Escalier gain de place Living



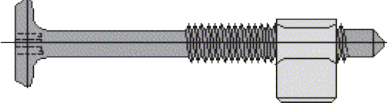

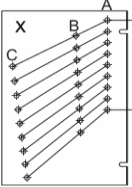

# Liste de pièces LIVING

Nombre de marches - 12

max. Hauteur sol / sol 285 cm

<p>1.</p>  <p>Nombre: 12</p>	<p>2.</p>  <p>Nombre 2</p>	<p>3.</p>  <p>Nombre 3</p>
<p>4.</p>  <p>Nombre 3</p>	<p>5.</p>  <p>Nombre: 2</p>	<p>6.</p>  <p>Nombre: 4</p>
<p>7.</p>  <p>Nombre: 4</p>	<p>8.</p>  <p>Nombre: 6 4,5x25</p>	<p>9.</p>  <p>Nombre: 48</p>
<p>10.</p>  <p>Nombre: 24+3 5x50</p>	<p>11.</p>  <p>Nombre: 3 5x70</p>	<p>12.</p>  <p>Nombre: 3 4x30</p>
<p>13.</p>  <p>Nombre: 4</p>	<p>14.</p>  <p>Nombre: 1</p>	<p>15.</p>  <p>Nombre: 1</p>

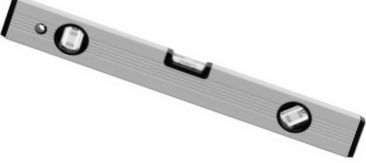
## Outillage nécessaire

 <p>SW10</p>	 <p>Ø 5mm</p>	 <p>SW 3/5</p>
		

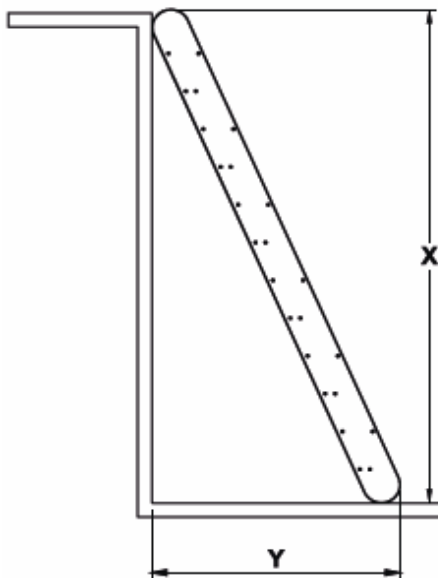

X [mm]	Y [mm]
2450	2030
2500	1966
2550	1899
2600	1828
2650	1752
2700	1670
2750	1581
2800	1485
2850	1375

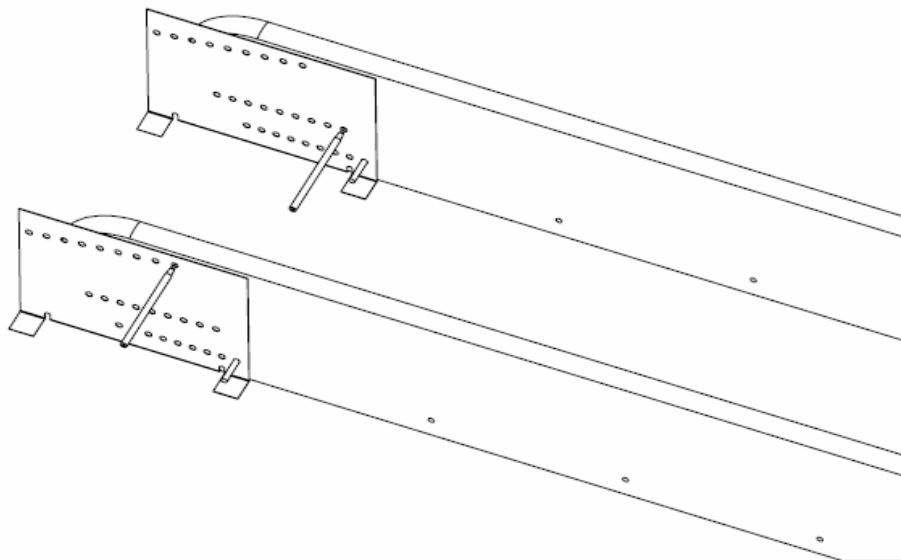
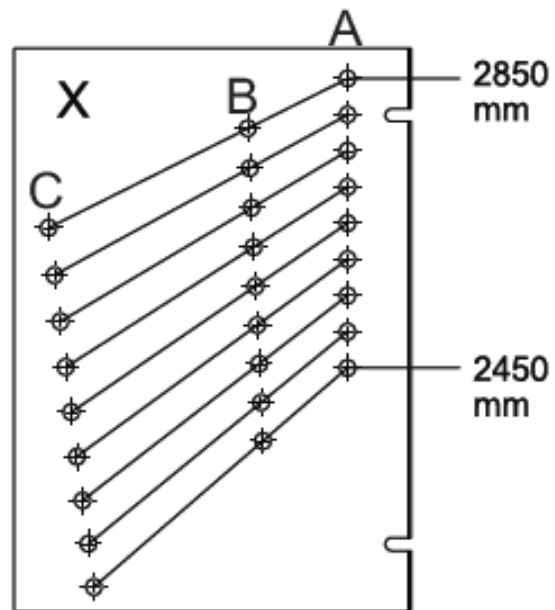

Après détermination de la hauteur de plafond, prendre la perçage fourni approprié et percer des trous (6mm) dans les parties latérales.

